



NINJAGO

71787



5



WARNING: CHOKING HAZARD.
Small parts. Not for children under 3 years.

⚠ **AVERTISSEMENT : RISQUE D'ÉTOUFFEMENT.**
Contient des petites pièces. Ne convient pas aux enfants de moins de 3 ans.

⚠ **ADVERTENCIA: PELIGRO DE ASFIXIA.**
No recomendado para niños menores de 3 años. Contiene piezas pequeñas.



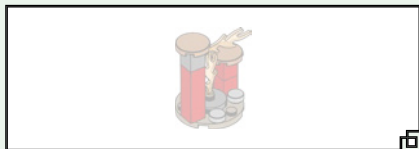
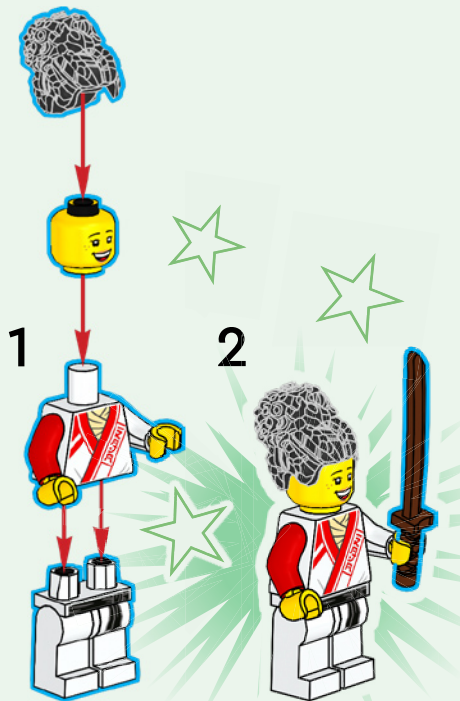

1



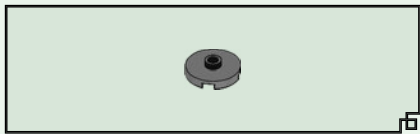

2



4



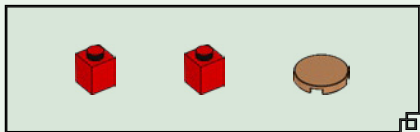

3

1

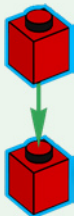

2

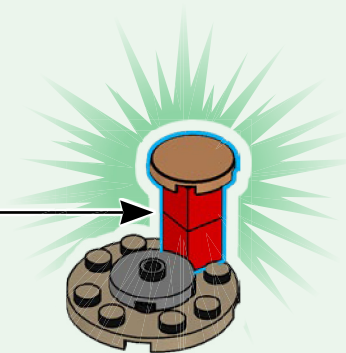



4



6



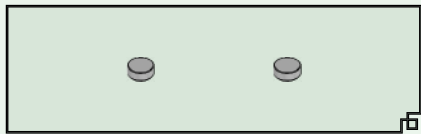

5



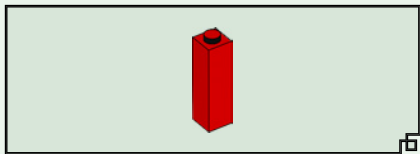

6



8





7

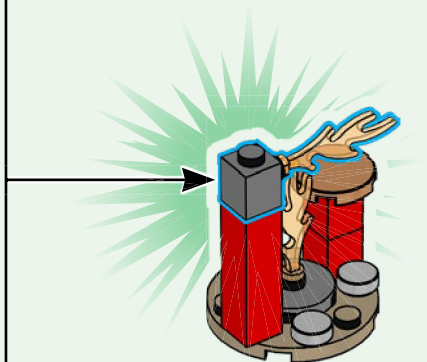
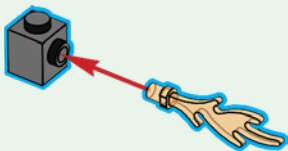

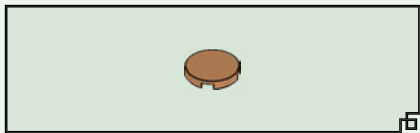

8



10



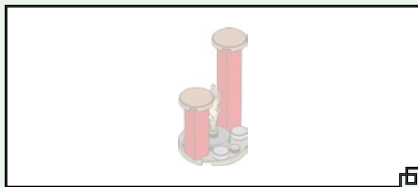

1



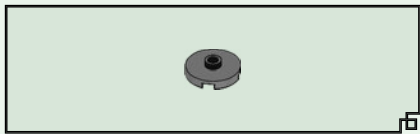

2

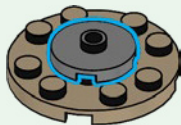



3



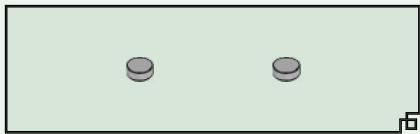

4



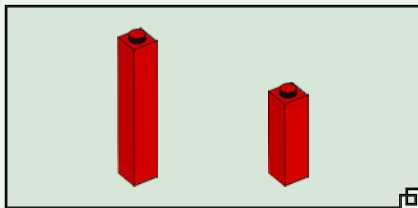

5

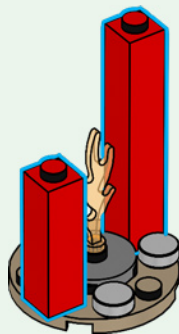

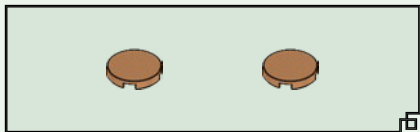

6

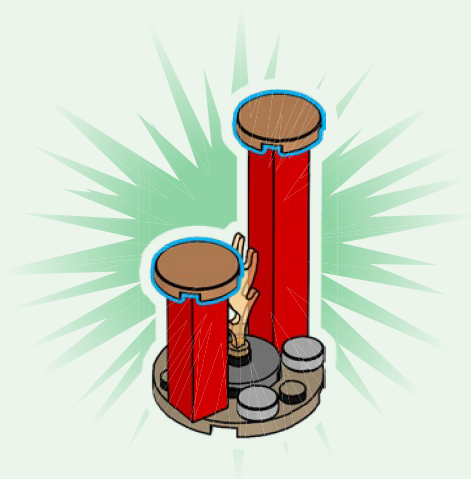



1



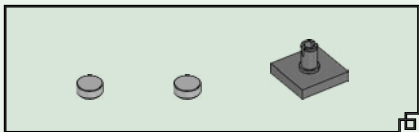

2

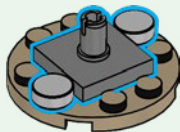



3

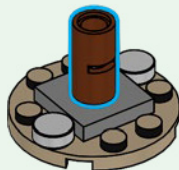



4

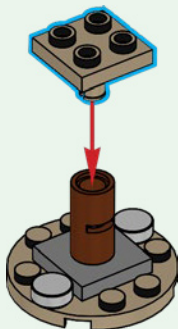

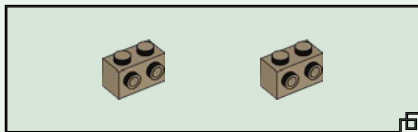

5

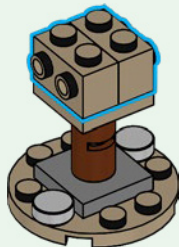

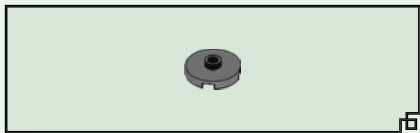

6

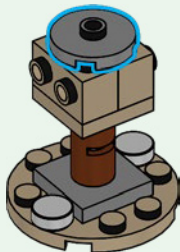

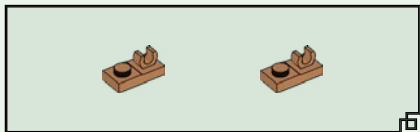

7

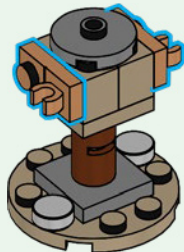

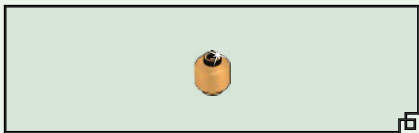

8

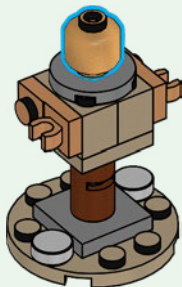



9

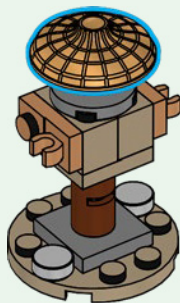

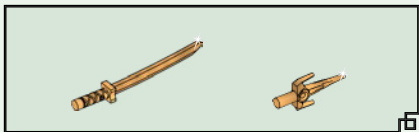

10



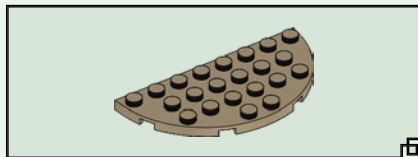
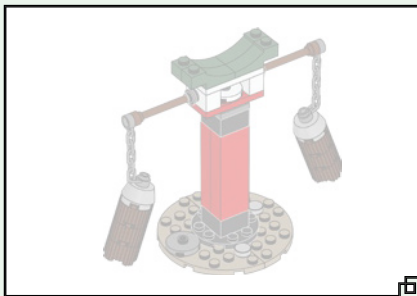

1

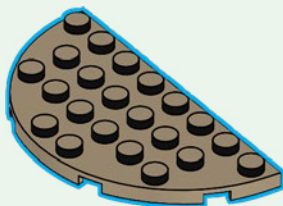

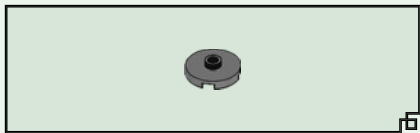

2

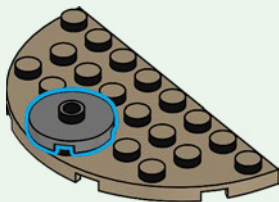



3

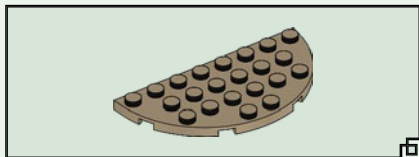
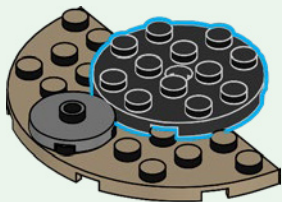

4

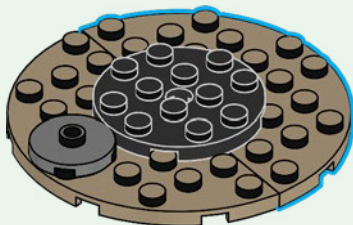

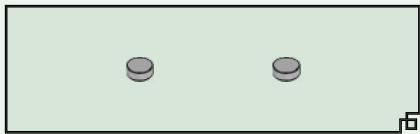

5

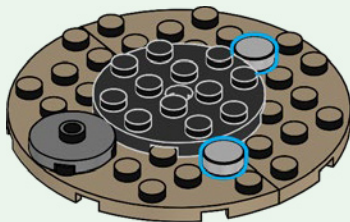

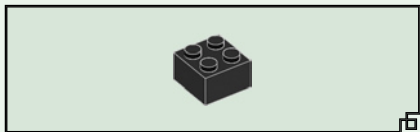

6

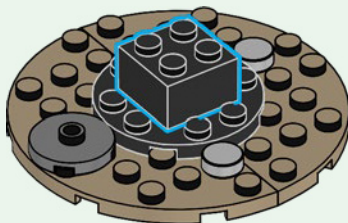

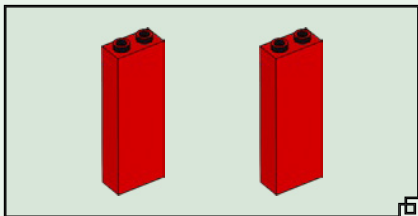

7

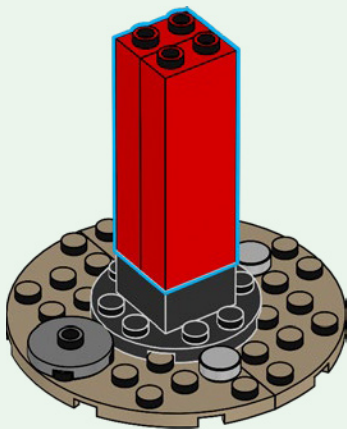

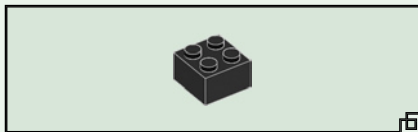

8

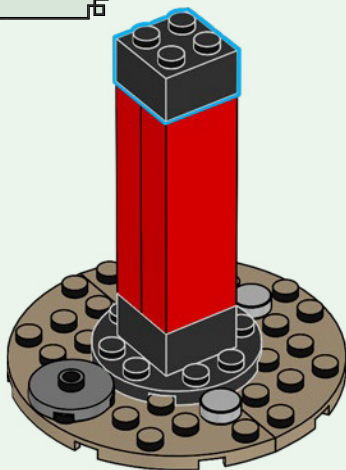

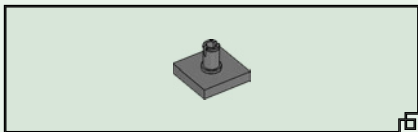

9

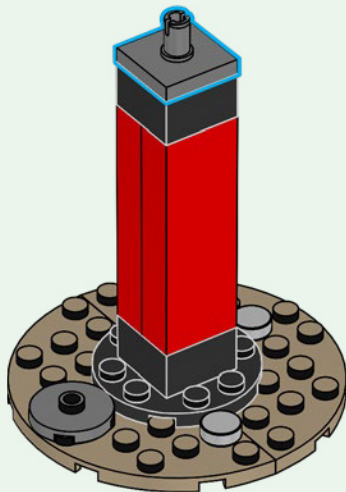

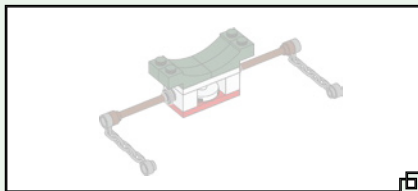

10

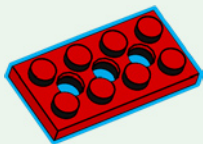

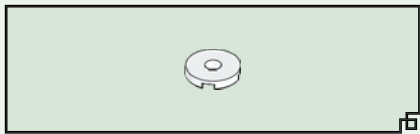

11

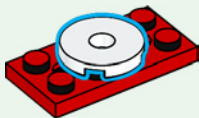

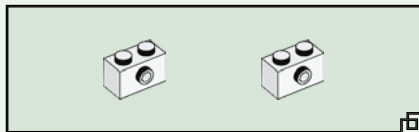

12

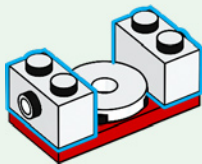



13

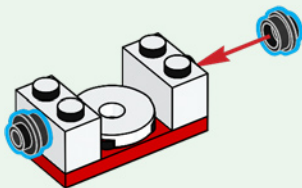

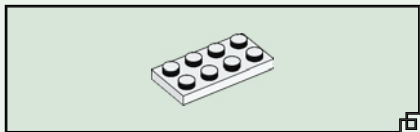

14

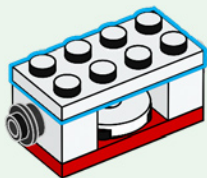

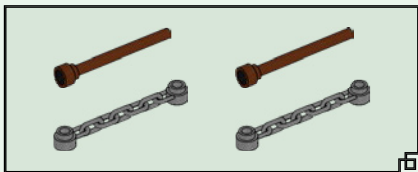
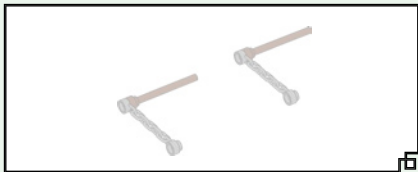

15

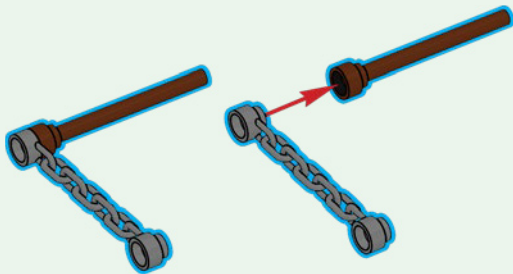

16

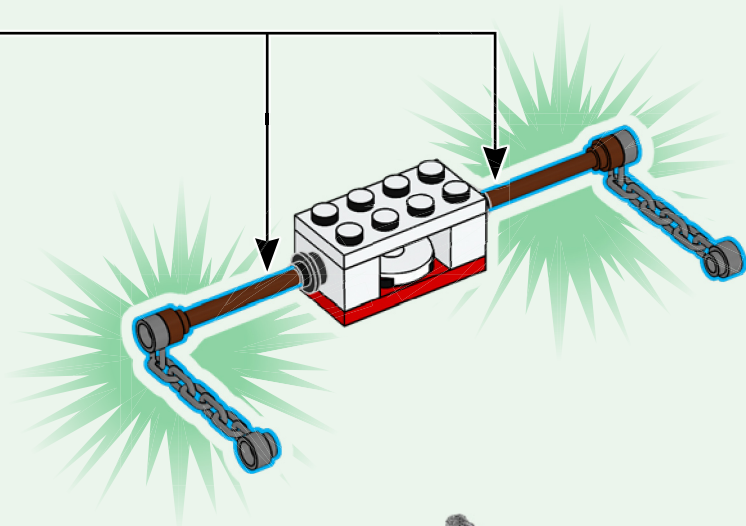

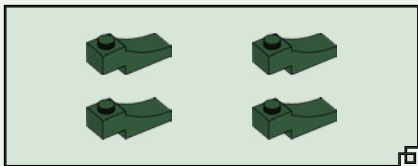

17

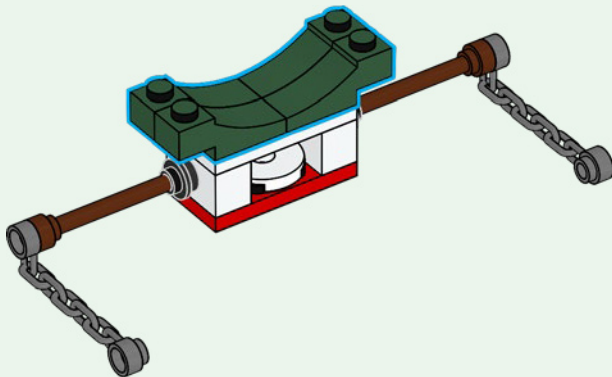

18

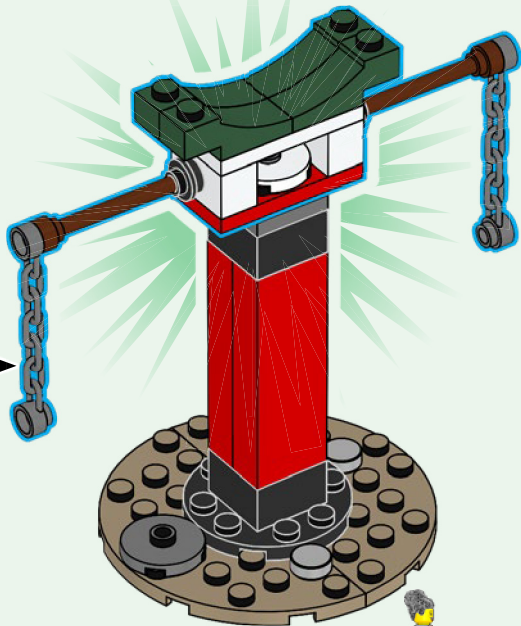

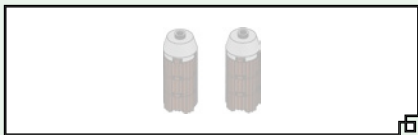

19

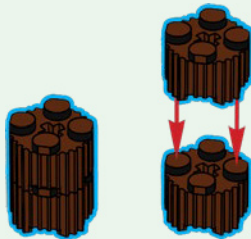



20



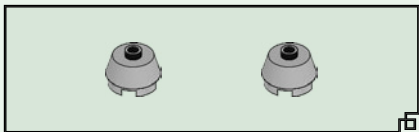

21

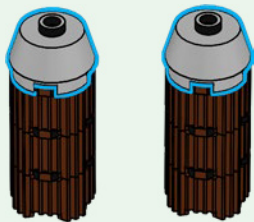

22

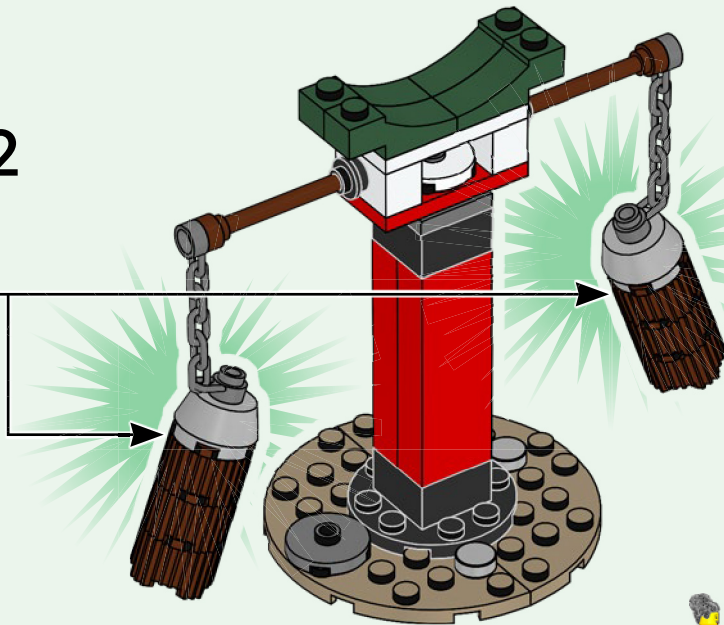

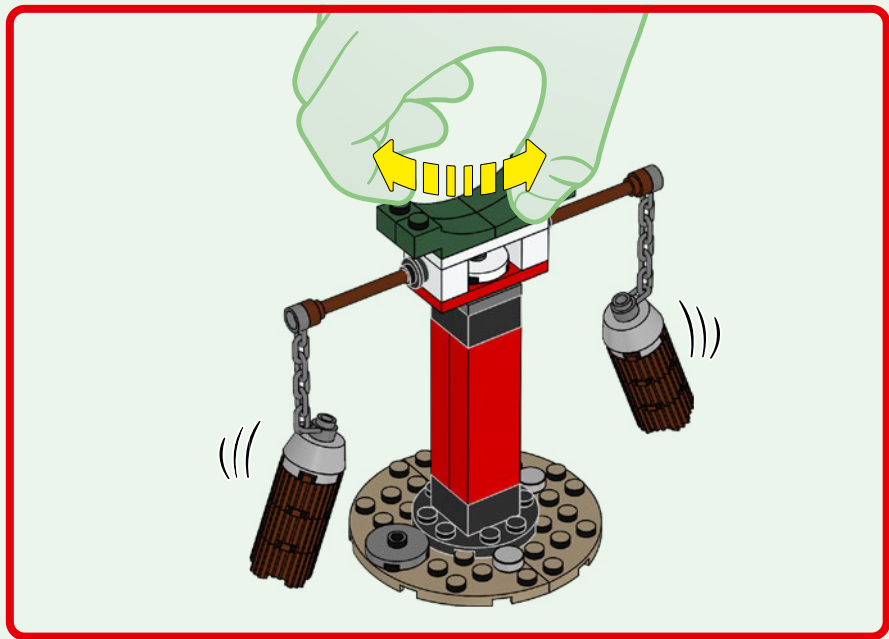

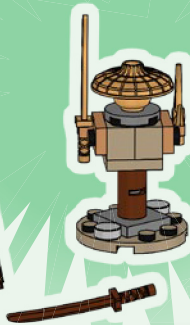
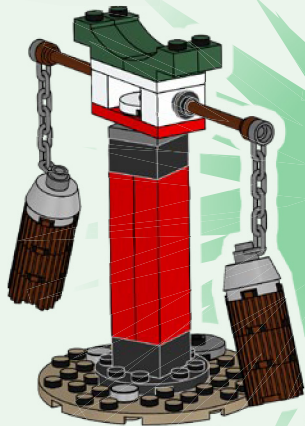

LEGO

NINJAGO







LEGO, the LEGO logo, NINJAGO and the NINJAGO logo are trademarks of the/
sont des marques de commerce du/son marcas registradas de LEGO Group.
©2023 The LEGO Group. 6449690

Rebuild
the
world™

